

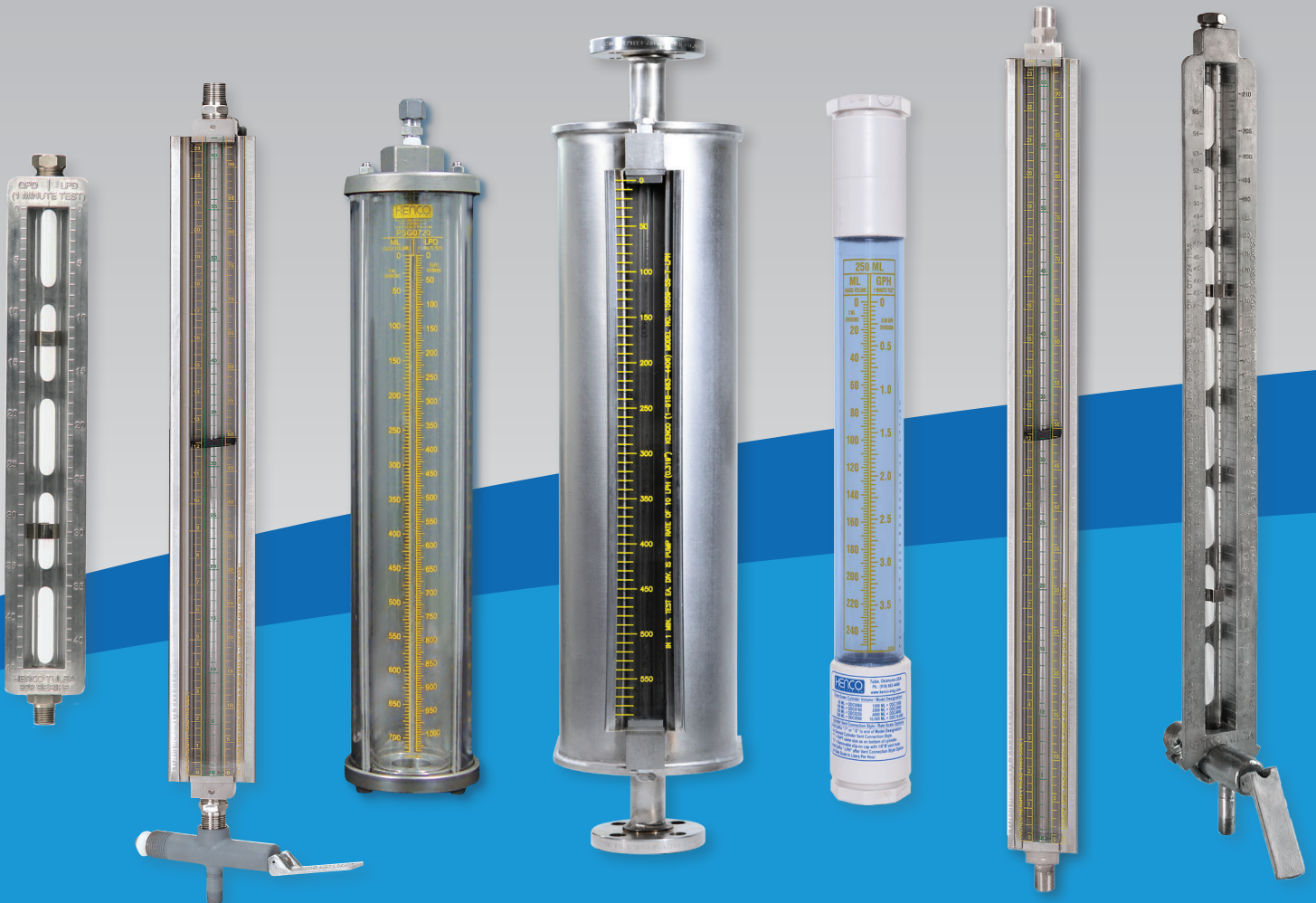

ADAPTABILITY & PRECISION

CALIBRATION GAUGES FOR CHEMICAL INJECTION SYSTEMS BY KENCO



ENGINEERED FOR ACCURACY

ISO 9001:2015 CERTIFIED



APPLICATIONS:

Kenco AccuRate® Pump Setting Gauges utilize precision scientific glass to provide the most accurate reading possible for calibrating the flow rate of a chemical metering pump. They are also used to periodically monitor the performance and accuracy of a chemical injection system. The AccuRate® gauge can also be used as the primary containment reservoir of a liquid that will be pumped into a chemical injection system.

THE ONE-MINUTE TEST:

To check the pumping rate of a chemical pump, isolate the chemical in the storage tank from the AccuRate® gauge. The decal on the gauge glass has (2) individual calibrated scales. The scale on the left side is a volume scale in milliliters; in a one-minute test, the scale will read the pump rate in milliliters. The scale on the right side will depend on what type of flow rate is required; i.e. U.S. Gallons by Volume (USG), Gallons Per Day (GPD), Gallons Per Hour (GPH), Liters Per Day (LPD), or Liters Per Hour (LPH). Keep the isolation valve closed and observe the number of marks the liquid level passes in one minute. This will give you the actual chemical pump rate. If the rate is not the one desired, make an adjustment to the chemical pump feed rate and conduct as many one-minute tests as is necessary to set the chemical pump rate to the rate desired.

GAUGE FEATURES:

1. Precision borosilicate glass sight tube delivers precision rate calibration from 0.05% to 0.2%. AccuRate® Pump Setting Gauges will calibrate pump rates up to 1095 Gallons Per Day (GPD) or 4,140 Liters Per Day (LPD).
2. Clear polycarbonate shield for high impact resistance is standard
3. Five (5) scale options are available: U.S. Gallons By Volume (USG), Gallons Per Day (GPD), Gallons Per Hour (GPH), Liters Per Day (LPD), and Liters Per Hour (LPH) - Standard volumetric scale in ML on all units.
4. Tubing connector on top of gauge is only supplied on units with 316 S.S. and PVC end plates.
5. Standard end plate materials are 316 S.S., PVC, CPVC, Hastelloy C-276 and Alloy 20. Other materials are available upon request.
6. Drain holes in lower end plate eliminate condensation.
7. Redline tape can be applied to the glass tube for better visibility of clear liquids. The redline tape will magnify visibility in the portion of the glass tube that contains liquid.

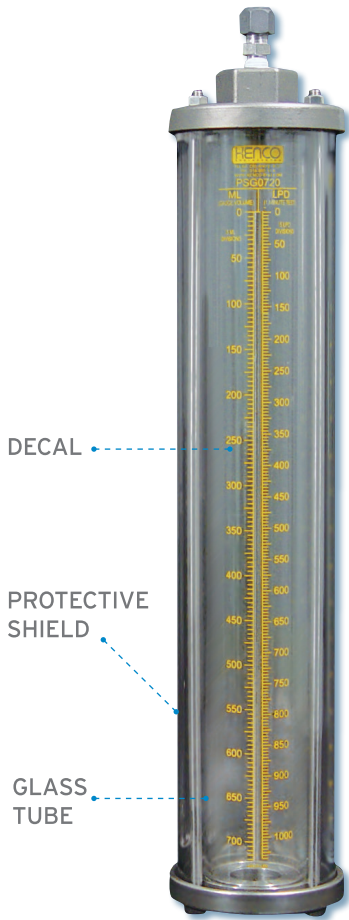

Common application for AccuRate® Pump Setting Gauge

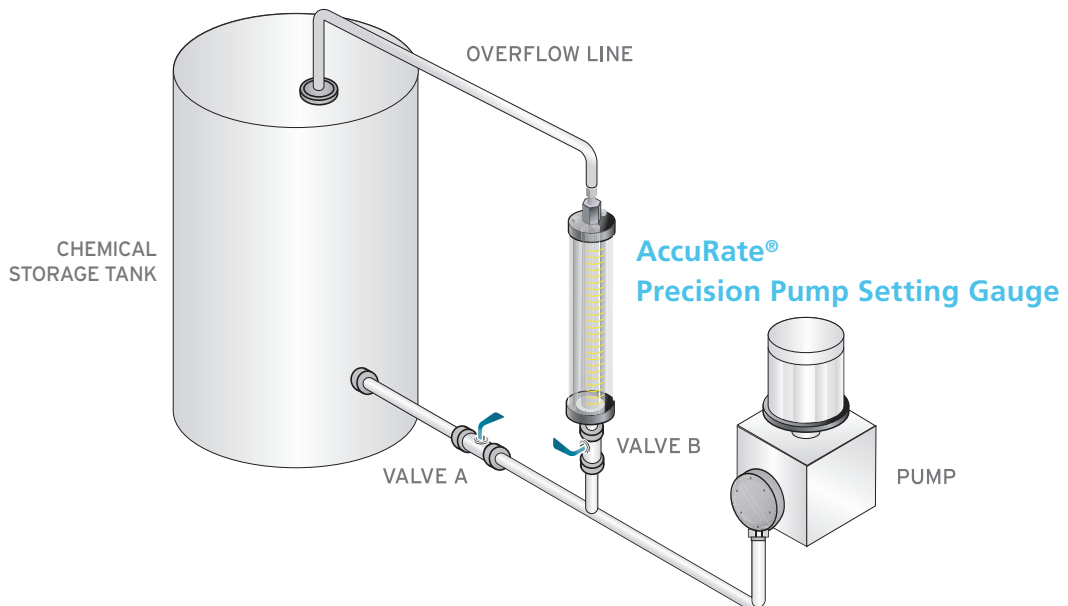

AccuRate® PUMP SETTING GAUGE SPECIFICATIONS

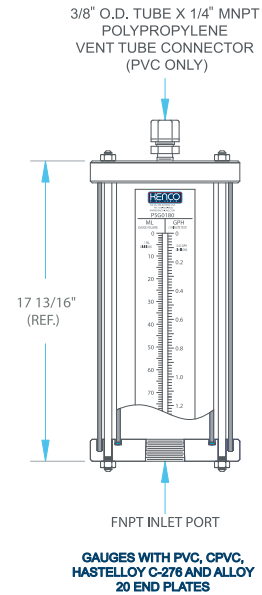
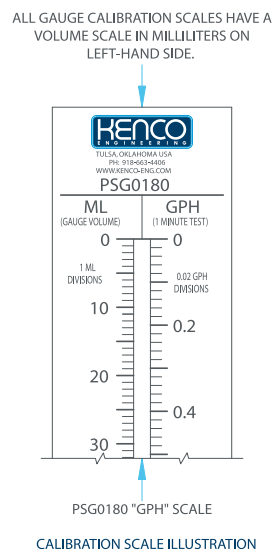
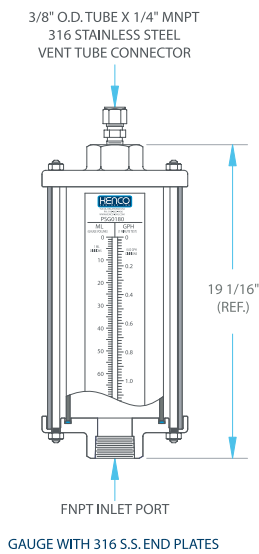

AccuRate® PUMP SETTING GAUGE SPECIFICATIONS

GAUGE MODEL NUMBER	END PLATE MATERIAL	GAUGE VOLUME		MAXIMUM PUMPING RATE (BASED ON A 1 MINUTE TEST)				INLET PORT SIZE	OVERALL GAUGE LENGTH	END PLATE O.D.
		ML	USG	GPH	GPD	LPH	LPD			
PSG0100	S	100	0.0264	1.58	38	6	144	1/2"	12-7/8"	2-7/8"
	P / CP / HC / A20								11-5/8"	3"
PSG0180	S	180	0.0476	2.84	68.5	10.8	258	1/2"	19-1/16"	2-7/8"
	P / CP / HC / A20								17-13/16"	3"
PSG0404	S	404	0.107	6.4	154	24.3	580	3/4"	19-1/16"	3-3/8"
	P / CP / HC / A20								17-13/16"	3-1/2"
PSG0720	S	720	0.19	11.4	274	43.2	1035	1"	19-1/16"	3-7/8"
	P / CP / HC / A20								17-13/16"	4"
PSG1620	S	1620	0.428	25.6	615	97	2330	1"	19-1/16"	4-7/8"
	P / CP / HC / A20								17-13/16"	5"
PSG2880	S	2880	0.76	45.6	1095	172	4140	1"	19-1/16"	5-7/8"
	P / CP / HC / A20								17-13/16"	6"

• To Order a Gauge with Redline Sight Tube Option, add suffix -RL to the End of the Gauge Model Number.

ORDERING SYSTEM

AccuRate® Pump Setting Gauge

REQUESTED BY: _____ COMPANY: _____
 ADDRESS: _____ CITY: _____ STATE: _____ ZIP: _____
 PHONE: _____ FAX: _____ EMAIL: _____

Gauge Model Number

PSG0100
 PSG0180
 PSG0404
 PSG0720
 PSG1620
 PSG2880

* End Plate Material

S = 316 Stainless Steel
 P = PVC
 CP = CPVC
 HC = Hastelloy C-276
 A20 = Alloy 20
 Other (Please specify above)

Gasket Material

A = Aflax
 B = Buna-N
 E = Ethylene Propylene
 V = Fluorocarbon
 T = PTFE Envelope w/
 Neoprene Filler
 Other (please specify above)

Calibration Scale

USG = U.S. Gallons by Volume
 GPH = Gallons Per Hour
 GPD = Gallons Per Day
 LPH = Liters Per Hour
 LPD = Liters Per Day

- Example Order Number: PSG0180-S-V-GPH
- Please contact Kenco to request a quote for options not covered by gauge specifications shown above.
- For a Redline glass strip, add - RL to end of part number.
- * Gauges constructed with end plate material options CP, HC and A20 supplied without tube connector fitting.

CALIBRATION POTS

CALIBRATION POTS FOR CALIBRATING CHEMICAL PUMPS

APPLICATIONS:

Calibration Pots provide an extremely accurate reading of the pumps output for a wide range of flow rates. The unit is installed between the suction side of the chemical pump and the chemical storage tank. The flow rate is checked by closing the valve between the storage tank and the Calibration Pot and observing the liquid level change in the calibrated scale for one minute.

FEATURES:

- The Calibration Pot is often the preferred option for offshore installations due to the robust design. The totally enclosed construction ensures maximum safety.
- Provide a means for accurately and precisely checking the feed rates of a chemical metering pump
- Individually hand calibrated to assure maximum accuracy

OPTIONS:

- Manufactured in 316 Stainless Steel, Painted Carbon Steel, Hastelloy C-276 and Alloy 20 as standard options. Other materials including PVC and CPVC available to meet your chemical resistance requirements.
- Customization is always an option. Give us your design criteria and we will design a unit to fit your needs and specifications.



CALIBRATION POTS AVAILABLE WITH FLANGED OR THREADED CONNECTIONS

COMMON APPLICATION

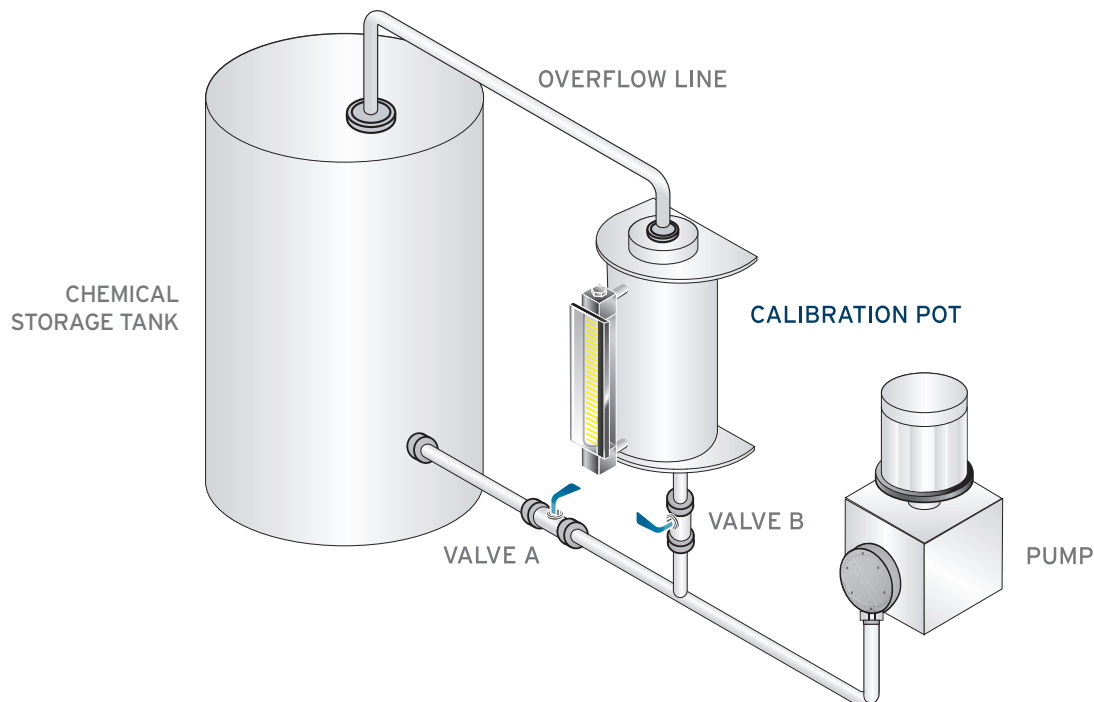

CALIBRATION POTS

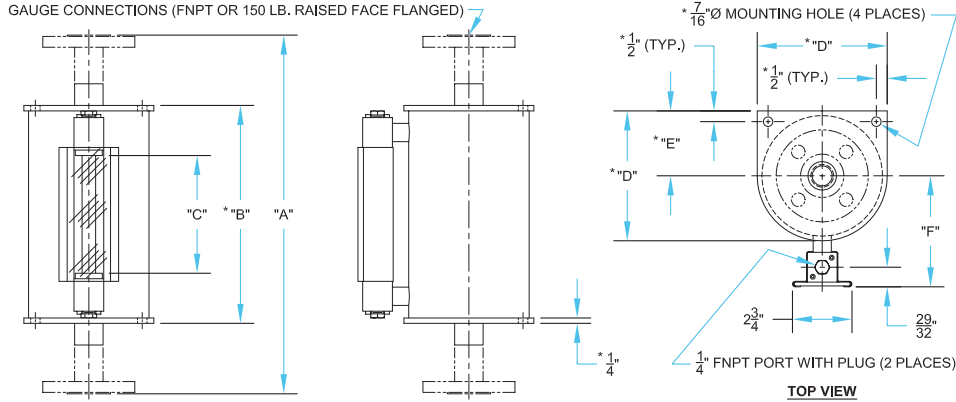

CALIBRATION POT SPECIFICATIONS

MODEL NUMBER (CONNECTION SIZE)		MAXIMUM PUMPING RATE (BASED ON A 1 MINUTE TEST)				VOLUME		A		* B	C	* D	* E	F
THREADED	FLANGED	GPH	GPD	LPH	LPD	GBV	LBV	FNPT	FLGD.					
15842 (3/4" FNPT)	15843 (3/4" 150#)	2.5	60	9.46	227.12	0.04	0.16	21-7/8"	24-3/8"	N/A	15-3/4"	N/A	N/A	2-7/8"
15844 (3/4" FNPT)	15845 (3/4" 150#)	5	120	18.93	454.25	0.08	0.32	27-1/8"	29-5/8"	N/A	21"	N/A	N/A	3"
15846 (3/4" FNPT)	15847 (3/4" 150#)	10	240	37.85	908.5	0.17	0.63	26-1/8"	30-5/8"	24-1/8"	19-1/2"	2-3/8"	1-3/16"	3-9/32"
15848 (1" FNPT)	15849 (1" 150#)	20	480	75.71	1816.99	0.33	1.26	24-1/4"	28-3/8"	21-7/8"	17-1/4"	3-1/4"	1-5/8"	3-25/32"
15850 (1" FNPT)	15851 (1" 150#)	40	960	151.42	3633.98	0.67	2.52	29-1/2"	33-5/8"	27-1/8"	22-1/2"	3-7/8"	1-15/16"	4-3/32"
15852 (1" FNPT)	15853 (1" 150#)	60	1440	227.12	5450.98	1	3.79	27"	31-1/8"	24-5/8"	20"	4-7/8"	2-7/16"	4-19/32"
15854 (1-1/2" FNPT)	15855 (1-1/2" 150#)	80	1920	302.83	7267.97	1.33	5.05	23-1/4"	26-5/8"	20-1/8"	15-1/2"	6"	3"	5-1/8"
15856 (1-1/2" FNPT)	15857 (1-1/2" 150#)	100	2400	378.54	9084.96	1.67	6.31	27-1/4"	30-5/8"	24-1/8"	19-1/2"	6"	3"	5-1/8"
15858 (2" FNPT)	15859 (2" 150#)	120	2880	454.25	10901.95	2	7.57	25-1/2"	28-5/8"	22-1/8"	17-1/2"	7"	3-1/2"	5-21/32"
15860 (2" FNPT)	15861 (2" 150#)	140	3360	529.96	12718.94	2.33	8.83	28-1/2"	31-5/8"	25-1/8"	20-1/2"	7"	3-1/2"	5-21/32"
15862 (2" FNPT)	15863 (2" 150#)	280	6720	1059.91	25437.89	4.67	17.67	30-7/8"	34"	27-1/2"	22-7/8"	9"	4-1/2"	6-21/32"
15864 (2" FNPT)	15865 (2" 150#)	440	10560	1665.58	39973.82	7.33	27.76	30-5/8"	33-3/4"	27-1/4"	22-5/8"	11-1/8"	5-9/16"	7-23/32"
15866 (2" FNPT)	15867 (2" 150#)	620	14880	2346.95	56326.75	10.33	39.12	30-1/4"	33-3/8"	26-7/8"	22-1/4"	13-1/8"	6-9/16"	8-23/32"

*Model number 15842 through 15845 gauges are not equipped with end plates. Model number 15846 through 15851 gauges are equipped with 1/4" thick end plates, but they are round and do not have 7/16" \varnothing mounting holes. See Kenco website for a detailed outline drawing of each model.

ORDERING SYSTEM Calibration Pots

REQUESTED BY: _____ COMPANY: _____
 ADDRESS: _____ CITY: _____ STATE: _____ ZIP: _____
 PHONE: _____ FAX: _____ EMAIL: _____

Cal Pot Model Number

15842 15849 15856
 15843 15850 15857
 15844 15851 15858
 15845 15852 15859
 15846 15853 15860
 15847 15854 15861
 15848 15855 15862

Material of Construction

CS = Carbon Steel
 SS = 316 Stainless Steel
 HC = Hastelloy C-276
 A20 = Alloy 20
 Other (please specify above)

Seal Material

A = Aflas
 B = Buna-N
 E = Ethylene Propylene
 V = Fluorocarbon
 T = FEP Encapsulated Silicone
 K = Kalrez 4079
 Other (please specify above)

Calibration Scale

GPH = Gallons Per Hour
 GPD = Gallons Per Day
 LPH = Liters Per Hour
 LPD = Liters Per Day
 GBV = Gallons By Volume
 LBV = Liters By Volume
 Other (please specify above)

- Example Order Number: 15842-SS-V-GPH
- Please contact Kenco to request a quote for options not covered by gauge specifications shown above.

DRAW DOWN CALIBRATION CYLINDER

APPLICATIONS:

- To calibrate the flow rate of chemical metering pumps and chemical injection systems
- To periodically monitor the performance and accuracy of a chemical injection system
- To insert accurate dosages of chemical into batch processes

FEATURES:

- Dual Scale:
 1. Total gauge volume in millimeters
 2. Gallons per Hour or Liters per Hour for a one minute test of calibration to determine the flow rate
- Polyester laminated scales are protected from attack by harsh chemicals
- Available in capacities ranging from 60 ML up to 10,000 ML size
- Models with threaded NPT connections on both ends and models with removable slip on top caps available
- Rugged construction using transparent PVC pipe and industrial grade PVC fittings
- Sight tube material is clear and impact resistant superior grade PVC
- Materials of construction are qualified to handle a wide range of chemicals
- Other connection types and connection sizes available



COMMON APPLICATION

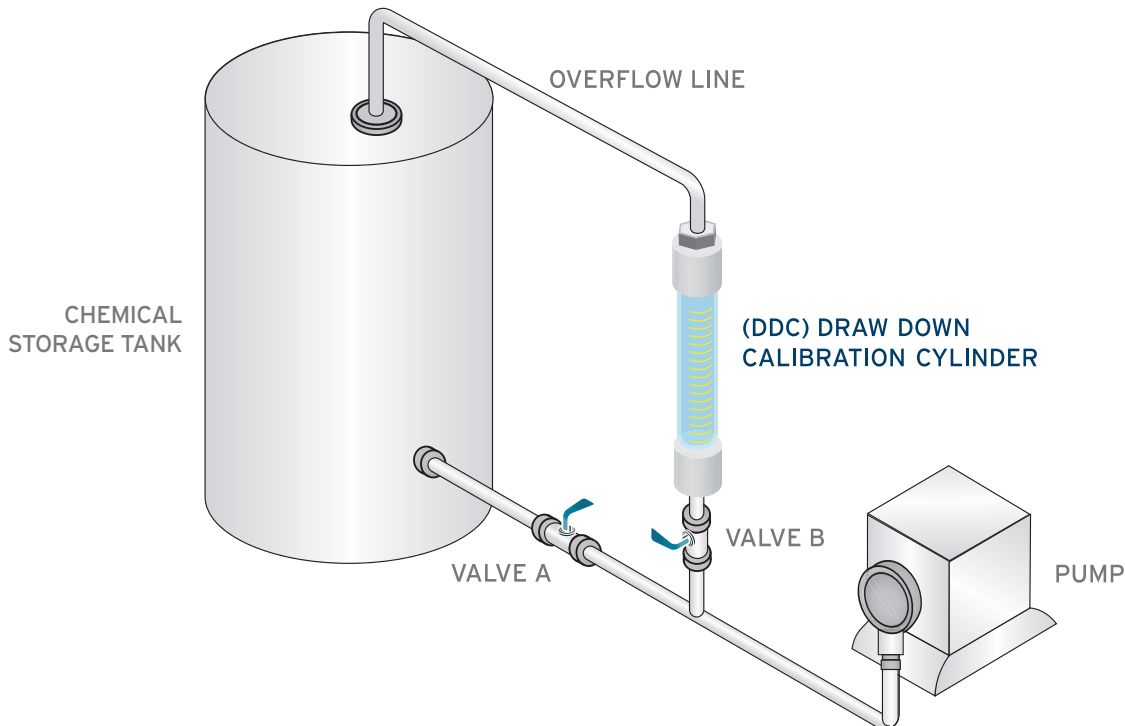

DRAW DOWN CALIBRATION CYLINDER GAUGE SPECIFICATIONS

GAUGE MODEL NUMBER		GAUGE VOLUME	MAXIMUM PUMP RATE		VOLUME / RATE SCALE DIVISIONS			"A"		"B"	"C"
FEMALE NPT	SLIP-ON CAP	ML	GPH	LPH	ML	GPH	LPH	FEMALE NPT	SLIP-ON CAP		
DDC0060-T	DDC0060-S	60	0.951	3.600	0.5	0.01	0.05	13 3/4"	12 11/16"	1 5/16"	1/4" FNPT
DDC0060-TLPH	DDC0060-S-LPH										
DDC0100-T	DDC0100-S	100	1.585	6	1	0.02	0.05	14 3/8"	13 5/16"	1 5/8"	1/2" FNPT
DDC0100-TLPH	DDC0100-S-LPH										
DDC0250-T	DDC0250-S	250	3.963	15	2	0.05	0.10	15 3/4"	14 7/16"	2 1/4"	1/2" FNPT
DDC0250-TLPH	DDC0250-S-LPH										
DDC0500-T	DDC0500-S	500	7.925	30	5	0.10	0.25	17 13/16"	16 3/8"	2 3/4"	3/4" FNPT
DDC0500-TLPH	DDC0500-S-LPH										
DDC1000-T	DDC1000-S	1000	15.850	60	5	0.10	0.25	27 1/16"	25 5/8"	2 3/4"	3/4" FNPT
DDC1000-TLPH	DDC1000-S-LPH										
DDC2000-T	DDC2000-S	2000	31.700	120	20	0.25	1	21 1/4"	19 7/16"	5"	2" FNPT
DDC2000-TLPH	DDC2000-S-LPH										
DDC4000-T	DDC4000-S	4000	63.401	240	20	0.25	1	31"	29 3/16"	5"	2" FNPT
DDC4000-TLPH	DDC4000-S-LPH										
DDC10,000-T	DDC10,000-S	10,000	158.503	600	100	2	5	36 7/8"	33 7/8"	7 1/4"	2" FNPT
DDC10,000-TLPH	DDC10,000-S-LPH										

Notes:

1. Calibration scale on gauge models with "-T" and "-S" suffix are in Milliliters by volume and Gallons Per Hour based on a one minute test.
2. Calibration scale on gauge models with "-TLPH" and "-SLPH" suffix are in Milliliters by volume and Liters Per Hour based on a one minute test.
3. Other gauge sizes are available. Please contact Kenco to request a quote for options not covered by gauge specifications shown above.
4. Female NPT Vent on "-T" is the same as inlet port size "C".
5. Slip-On Cap on "-S" model is removable and has a 1/8" diameter vent hole through center.
6. Maximum Pump Rates and Rate Scale Divisions in Gallons per Hour and Liters per Hour are based on a one minute test.

DRAW DOWN CALIBRATION CYLINDER

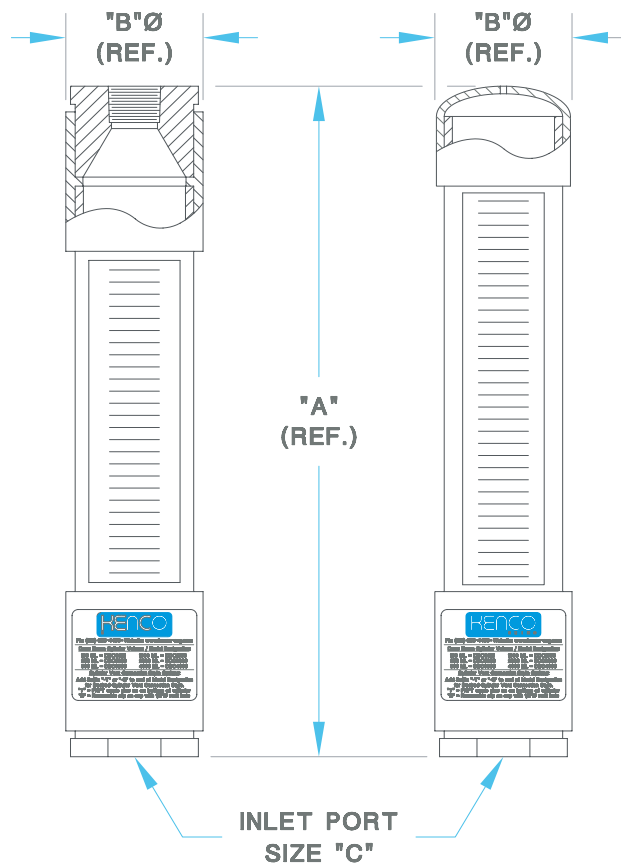

INJECTION RATE GAUGES

The 5700, 7000 and 17000 series gauges are armored rate setting gauges with NPT or flanged connections at each end. These gauges provide a visual means for setting and monitoring the pump rate of a chemical metering pump. The gauges operate in low to medium pressure applications.

5700 RATE GAUGE WITH 1/2" CONNECTIONS



5700 Rate Gauge with Optional Flange Connection

7000 RATE GAUGE WITH 3/4" TEST VALVE CONNECTION

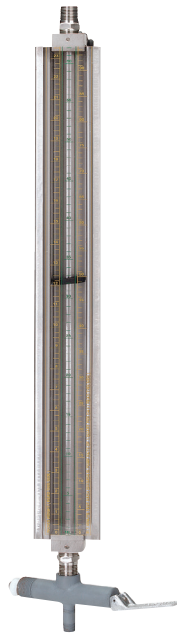

17000 RATE GAUGE WITH 1" CONNECTIONS



5700, 7000 AND 17000 SERIES GAUGE SPECIFICATIONS

The armored design of the gauge offers maximum protection for the sight tube from mechanical impact. Three sides of the gauge are protected with a metal frame, while the face of the gauge is protected with an impact resistant polycarbonate shield. This shield can be custom calibrated to read tank volume or any other desired calibration. A wide variety of wetted materials and seals are available to ensure compatibility with whatever liquid is being used. For mounting purposes, a mounting lug is welded to the back of the gauge.

The 5700 rate gauge has 1/2" MNPT x 3/8" FNPT threaded process connections. 1/2" to 2" flanged process connections are also available. The standard sight tube is 5/8" O.D. glass. Other sight tube options are also available upon request.

The 7000 Injection Rate Gauge is of the same construction as the 5700 gauge but is provided with a spring-loaded test valve similar to the valve supplied on the 779 Drum Gauge. The test valve is used to isolate the chemical supply tank from the gauge to conduct a one minute calibration test for the chemical pump.

The 17000 rate gauge is fitted with 1" MNPT process connections (flanged process connections are also available). The standard sight tube is 1" O.D. glass, which makes it ideal for viscous liquids.

SPECIAL GAUGE APPLICATION - CHEMICAL INJECTION SYSTEMS

5700, 7000 and 17000 gauges are used to calibrate chemical injection systems. The injection rate of a chemical metering pump is checked by closing a valve between the gauge and the chemical storage tank and observing the change in liquid height in one minute. Using the rate scale on the front of the polycarbonate shield, count the number of marks the liquid level passed during the one minute test period. This will give you the actual chemical pump rate. If the rate is not the one desired, make an adjustment to the chemical pump feed rate, and conduct as many one minute tests as is necessary to set the chemical pump to the rate desired. If a higher pump rate is required, the test period can be shortened to 30 seconds or 15 seconds or lengthened to a 2 minute test.

SILK SCREENED RATE SCALES AND CUSTOM ENGRAVED SCALES:

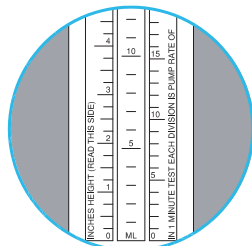

"RH"

Silk screened rate/height shield calibrated in quarts per day, milliliters per minute and height in inches

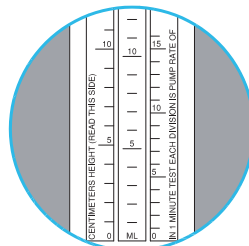

"MRH"

Silk screened metric rate/height shield calibrated in liters per day, milliliters per minute and height in centimeters

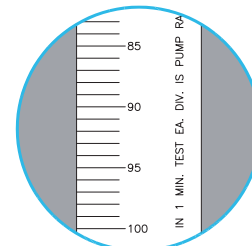

"S"

Custom engraved shield with scale(s) to meet your application requirements (tank volume, percent, etc.)

DRUM GAUGES

MODELS 596, K596, 599, K599, 779, 779-KS, 779-PB, 787, 810, 810-PB

APPLICATIONS:

KENCO Drum Gauges are an important part of a chemical injection skid. Drum Gauges are used to measure the liquid level inventory in horizontal 55 gallon chemical storage tanks. In addition, several models come complete with a test valve to set the injection rate of a chemical metering pump.

FEATURES:

- Volume Scale is calibrated in Gallons and Liters
- Chemical injection rate scale is calibrated in Quarts/24 Hours and Liters/24 Hours
- Available in a wide range of materials for ultimate corrosion resistance
- Models available to accommodate diaphragm operated pumps
- Can handle pump rates up to 19.5 gallons or 74 liters per day
- Installs easily in 3/4" NPS outlet of drum head
- Adjustable Stainless Steel gauge markers for easy calibration

THE ONE-MINUTE TEST

To check the pumping rate of a chemical pump, depress the valve handle (or close the ball valve on Model 599). This will isolate the level gauge from the chemical storage tank. Hold the valve closed for one minute and observe the change in level on the scale cast inside the gauge frame. The scale on the left hand side of the gauge glass is calibrated in quarts per 24 hours and the scale on the right is calibrated in liters per 24 hours. The rate observed is the actual chemical pump rate. If the rate is not the one desired, make an adjustment to the chemical pump feed rate and conduct as many one minute tests as is necessary to set the chemical pump rate to the rate desired.

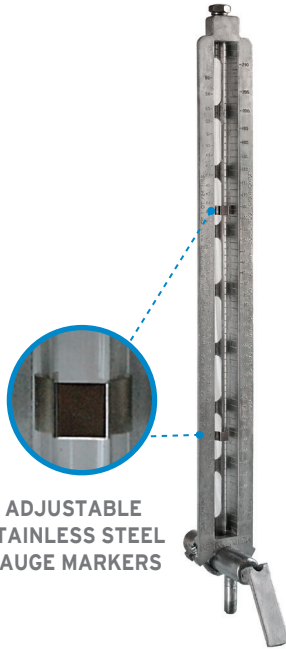

ADJUSTABLE
STAINLESS STEEL
GAUGE MARKERS

ORDERING SYSTEM

Drum Gauges

REQUESTED BY: _____ COMPANY: _____

ADDRESS: _____ CITY: _____ STATE: _____ ZIP: _____

PHONE: _____ FAX: _____ EMAIL : _____

Drum Gauge Style

- 596 = 596 Drum Gauge
(Only available with PVC Mounting Nipple)
- K596 = K596 Drum Gauge
(Only available with C.S./304 S.S. Mounting Nipple)
- K599 = K599 Drum Gauge
(Only available with C.S./304 S.S. Mounting Nipple)
- 779 = 779 Drum Gauge
- 779-KS = 779-KS Drum Gauge
(Only available with C.S./304 S.S. Mounting Nipple)
- 787 = 787 Drum Gauge
(Only available with C.S./304 S.S. Mounting Nipple)
- 810 = 810 Drum Gauge

Wetted Valve Material*

- CS = Carbon Steel (Leave Blank)
- S = 304 Stainless Steel
- PB = PVC
- Other (Please specify above)

Vent Connection

- None (Leave Blank)
- V = 1/4" FNPT

O-ring Seal Material

- A = Aflas (Leave Blank)
- B = Buna-N
- E = Ethylene Propylene
- N = Neoprene
- VI = Fluorocarbon
- *T = FEP Encapsulated Silicone on Drum Gauges with no vent connection. PTFE on Drum Gauges with a 1/4" FNPT vent connection.

• Example Order Number: 779-KS-S-V-VI

* Seal Material option "T" not available on Drum Gauge models 779 and 810 with PVC Test Valve Nipple.

DRUM GAUGE OPTIONS



K596 DRUM GAUGE

Mounts in the 3/4" outlet of a horizontal 55 gallon drum. The glass sight tube is protected by a cast aluminum frame which is calibrated in gallons and liters, indicating the liquid content of the drum.



779 DRUM GAUGE

Comes complete with a spring loaded test valve for checking injection rates of chemical pumps. This gauge also mounts in the 3/4" tank outlet and indicates tank volume in gallons and liters. The connection for the chemical pump suction line is 1/4" MNPT and is located as shown in the photograph.



810 DRUM GAUGE

The same as a 779 Drum Gauge, except valve nipple is longer to compensate for the vented elbow and elbow clamp supplied with this unit. The gauge is supplied with a vented 2" malleable iron elbow for refilling the drum and a test valve for checking the pump rate.



779-PB DRUM GAUGE

Has a heavy-duty PVC head with a push-pull test valve. The Drum Gauge frame is our standard cast aluminum. There is a brace to support the weight of the gauge that is connected to the top of the drum rim and it also stabilizes the gauge from lateral movement. It has a 1/4" female NPT outlet.



779-KS DRUM GAUGE

Is designed to accommodate the mounting of some diaphragm operated chemical pumps on its side mounted 1/4" MNPT outlet. Use this gauge to check the operation of any chemical pump. The valve body has an extra long throat.



K599 DRUM GAUGE

Supplied with a 3/4" ball valve which when closed provides a means for checking the pump rate of a chemical pump. The connection for the chemical pump suction port is 1/4" FNPT and is located on the front of the mounting nipple.



787 DRUM GAUGE

Provides a visual gauge indicating the chemical content of the drum and is supplied with a vented 2" elbow for refilling the drum. The gauge is secured to the malleable iron elbow with a stainless steel clamp.

TROUBLESHOOTING: When the check valve of the chemical pump is not functioning properly, the fluid level in the sight tube of the drum gauge will pulsate between pump strokes when the valve of the gauge is closed.



ELBOW
Optional vented 2" malleable iron elbow with a stainless steel clamp. (comes with 787 and 810)

OPTIONAL VENT CONNECTION

The Drum Gauges can be vented to atmosphere. These gauges can be supplied with a 1/4" FNPT connection to vent the gauge back into the tank. To specify gauges with this connection, add "V" to the product number, i.e. 779-V.



929 PUMP SETTING GAUGE

MODEL 929-1-S

Gauge mounts in suction line between reservoir and chemical pump and allows you to accurately calibrate pump to the desired amount of chemical to be injected. It provides a visual indication of liquid in the reservoir as well as a rapid means for setting the chemical pump. Rate scale on left side is marked and labeled in quarts per day and rate scale on right side is marked and labeled in liters per day.

MODEL 929-1-S-MRH

Same as 929-1-S except with a clear polycarbonate sight tube shield with silk screened Metric Rate and Height scales. Scales are in Centimeters, Milliliters and Liters Per Day based on a one minute test.

MODEL 929-2

Same as 929-1-S except lower gauge connection is a 1/4" quick disconnect plug meeting industrial interchangeability requirements. This allows gauge to be easily moved to various quick disconnect coupler locations.



ADJUSTABLE STAINLESS STEEL GAUGE MARKERS



MODEL 929-1-S

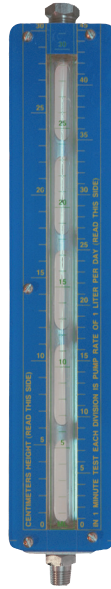

MODEL 929-1-S-MRH

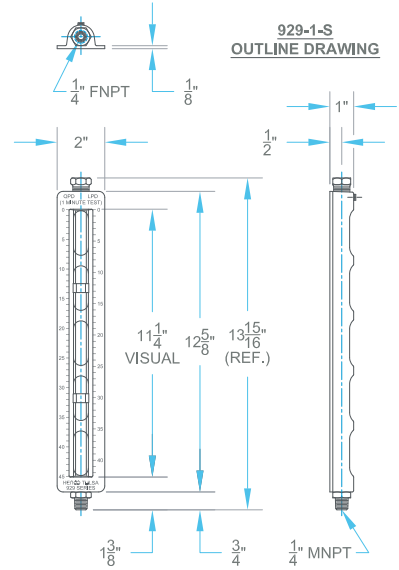

Model Specifications

MODEL NUMBER	BASIC MODEL DESCRIPTION	*MAXIMUM PUMP RATE	*RATE SCALE DIVISIONS	MOUNTING THREAD	VENT SIZE	WETTED METALS	SIGHT TUBE	SEAL MATERIAL
929-1-S	GAUGE ONLY	45 QPD 42.59 LPD	1 QPD / 1 LPD	1/4" MNPT	1/4" FNPT	303 S.S.	GLASS	AFLAS
929-1-S-MRH			1 LPD / 1 ML					
929-1-S6	GAUGE ONLY		1 QPD / 1 LPD	1/4" MNPT	1/4" FNPT	316 S.S.	GLASS	AFLAS
929-1-S6-MRH			1 LPD / 1 ML					
929-2	929-1-S w/COUPLER PLUG		1 QPD / 1 LPD	1/4" CPLR. PLUG	1/4" FNPT	C.S. / 303 S.S.	GLASS	AFLAS
929-2-MRH			1 LPD / 1 ML					

*Maximum Pump Rates are based on a one minute test. Rate Scale Divisions in Quarts Per Day / Liters Per Day are based on a one minute test and Scale Divisions in Milliliters are based on gauge volume.

ORDERING SYSTEM

929 Pump Setting Gauges

REQUESTED BY: _____ COMPANY: _____

ADDRESS: _____ CITY: _____ STATE: _____ ZIP: _____

PHONE: _____ FAX: _____ EMAIL: _____

Model Number

929-1-S 929-1-S6-MRH
 929-1-S-MRH 929-2
 929-1-S6 929-2-MRH

O-ring Seal Material Options

A = Aflas (Leave Blank)
 B = Buna-N
 E = Ethylene Propylene
 V = Fluorocarbon
 T = PTFE

Represented by:

Kenco Sales Offices:

Headquarters

10001 E. 54th St.
 Tulsa, OK 74146
 phone 918.663.4406
 fax 918.663.4480
 www.kenco-eng.com
 email: info@kenco-eng.com

Baton Rouge Office

11616 Industriplex, Suite 7
 Baton Rouge, LA 70809
 phone 225.755.1912
 fax 225.755.1913
 www.kenco-eng.com
 email: kenco-la@kenco-eng.com

84375 (4-19-2021)

