

Stainless steel centrifugal pumps

FOR THE PHARMACEUTICAL INDUSTRIES

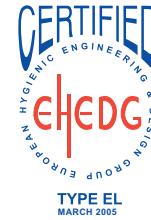

The PHP2 series of Packo pumps are the result of over 50 years of experience in the manufacture of stainless steel for the food and the pharmaceutical industries.

Based on the FP2 model (for sanitary applications in general) the construction has been adapted to meet the even higher demands required by pure water, pharmaceutical CIP/SIP and WFI installations.

The PHP2 pump range is available up to 115 m³/h, 110 mwc and 45 kW.

They are manufactured in Packo's state-of-the-art ISO 9001 certified production facilities in Diksmuide, Belgium.

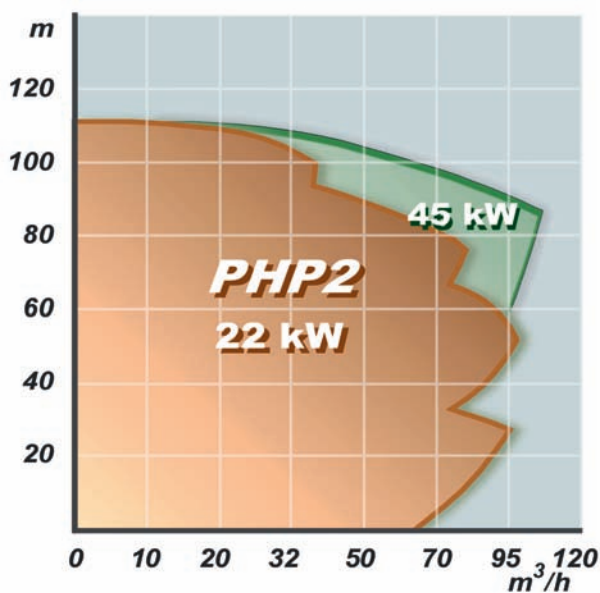

Optimum balance between sterile design, reliability, efficiency and NPSH

The Most Noble Materials

- All parts in contact with the medium are AISI 316L/DIN 1.4404 or equivalent. Impellers are stainless steel 1.4435 and fabricated from raw materials.
- Materials that are not in contact, e.g. the adapter flange, motor base and motor shroud, are also made of stainless steel.

Sterile design

- Crevice free design with absence of bacteria traps. According to ASME BPE 2009 and EHEDG certified.
- Easy to clean (CIP) and sterilise (SIP).
- Fully drainable (Many drain options).
- Sterile fittings (Many options).

Functional design

- Modular design using standard components: standard motors, standard seals.
- Solid construction: wall thickness up to **30 mm**
- Low noise. Stainless steel motor shroud is mounted on shock absorbers.

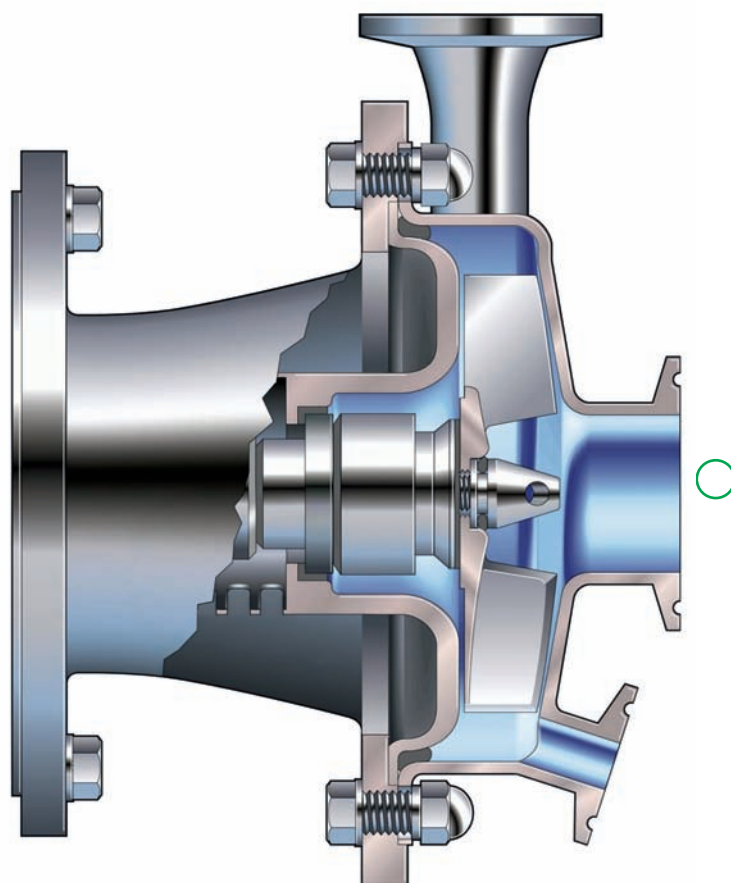

Sterile Seals

- Sterile mechanical seal ideally suited to handle liquids with poor lubrication properties (e.g. WFI). Special seal materials and configurations available.
- Only two seal diameters for the entire PHP2 pump range.
- The seal is according to DIN, ISO and AFNOR standards.
- FDA and USP class VI certified materials.

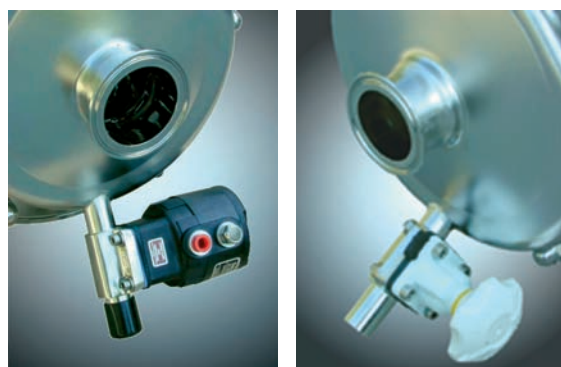

Many drain options (automatic or manual drain valve)

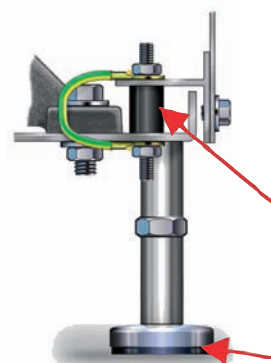

Low vibration Low noise

- Stainless steel motor shrouds on larger motors are mounted on shock absorbers.
- Adjustable feet on rubber pad (optional).

The perfect surface finish Electropolish

All stainless steel parts are degreased, pickled, passivated and electropolished according to the Packo procedure POS-ADND-FLEP 1008. This offers an extremely low microroughness resulting in a highly increased resistance to corrosion, adhesion and the ultimate bacteriological purity. All parts in contact have a guaranteed surface roughness. Values of less than $0.4 \mu\text{m Ra}$ are available. Research has proven that an Electropolished surface finish reduces the amount of rouge within the pump.

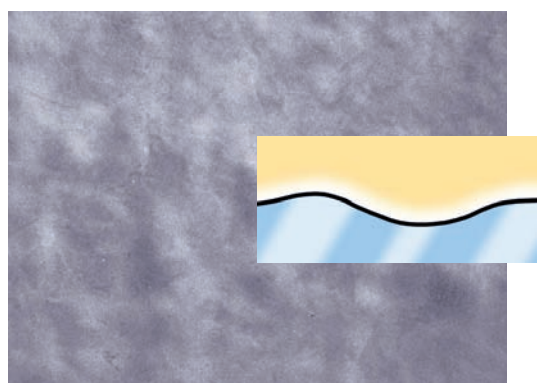
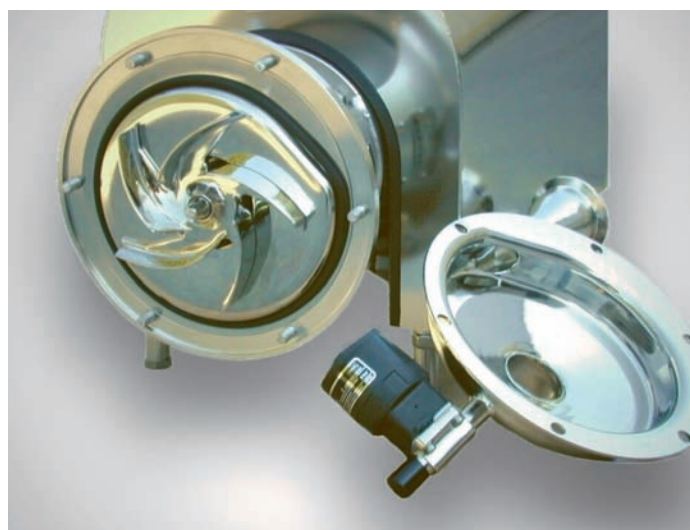

Electropolished surface (x 400)

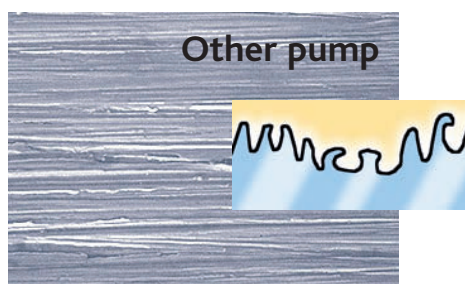

Mechanical polishing



Packo has its own Electropolishing division.

For more than 35 years Packo has specialized in Electropolishing surface treatments and has now become Europeans leading company in polishing for pharmaceutical applications.



TYPE PRP

Pharmaceutical CIP return pump - Scavenge pump



The PRP pump consists of the same components as the PHP. Only the pump casing is different, i.e. the same impeller, the same seals, etc.

ADVANTAGES

- Large clearances between the impeller and the pump casing. Less risk of contact contrary to liquid ring pumps.
- Lower NPSH, higher efficiency and lower noise level compared with liquid ring pumps.
- Flat head-flow curve. The pump can run against closed valve without providing extra high pressure or absorbing more power.



Improved mechanical seal

For CIP return applications in which a risk of dry running always exists Packo can offer the NanoPad seal. Its seal faces consist of specially treated silicone carbide to impart self lubricating properties whilst maintaining the same hardness and durability of silicone carbide.

For this reason the seal is also very appropriate for sterilisation while the pump is running. The seals are FDA and USP approved.



single seal SiC/SiC dry running



Packo solution: NanoPad seal



TYPE FMSV

Multi-stage pump

For high pressure, low flow.
Fully drainable



Certification and supplier documents

For all PHP and PRP pumps Packo provides FDA, DIN EN 10204/2.1 or 3.1, FDA and USP class VI material certification and certified measurements of performance and surface roughness.

Internal FAT (factory acceptance test)

Every single pump is tested in accordance to our internal FAT procedure as registered in our ISO 9001 handbook.

- Performance test
- Roughness
- Hydrostatic test

Certification also available on δ -ferrite, NPSH, pressure test, noise level, ...

